

PLATINUM®

SUN & SHADE

KOLLEKTIONSHEFT / COLLECTION BOOKLET 2025

INHALT / CONTENT

PLATINUM SUN & SHADE KOLLEKTION / COLLECTION	04	AUSSENROLLOS / OUTDOOR ROLLER BLINDS	16
SONNENSEGEL / SHADE SAILS	06	PERGOLEN / PERGOLAS	18
Coolfit® wasser- und winddurchlässig / water and air permeable	06	Optiva pergola aluminum / aluminium pergola	18
Dreamsail® wasserabweisend / water repellent	08	Bauen wir unsere eigene Holzpergola / build your own pergola	20
BEFESTIGUNGSMATERIALIEN / MOUNTING MATERIALS	10	BALKON- BESCHATTUNG / BALCONY	22
HARMONICA SONNENSEGEL / HARMONICA SHADE SAILS	12	Balkon Sichtschutze / Balcony screens	22
Coolfit® wasser- und winddurchlässig / water and air permeable	12	Flex frame	23
Prosail® wasserdicht / waterproof	14	AUSWAHLHILFE / DECISION AID	24



PLATINUM SUN & SHADE

Unser Ziel ist es, Ihnen die perfekte Freude an sonnigen Tagen zu bieten – und dieses Versprechen nehmen wir sehr ernst. Jedes Produkt der Platinum Sun & Shade-Kollektion wird von unserem niederländischen Designteam mit höchster Sorgfalt und Liebe zum Detail entworfen, wobei Ästhetik und Benutzerfreundlichkeit im Vordergrund stehen. Ein Platinum-Produkt spendet nicht nur Schatten, sondern setzt zugleich ein stilvolles Highlight in jeder Outdoor-Umgebung. Es schafft Sicherheit, Komfort und bereichert die Atmosphäre auf Terrassen, Balkonen und in Gärten gleichermaßen. Entdecken Sie unsere Kollektion und genießen Sie die perfekte Balance aus Stil und Funktion.

Optimal enjoyment of a sunny day. That's what we aim to provide, and we take it very seriously. Each product has been designed by our own Dutch design team, with great attention to aesthetics and usability. A Platinum Sun & Shade product not only offers shade but also serves as the finishing touch to any outdoor setting. It provides safety, comfort, and truly enhances the atmosphere in any garden, on any patio, or balcony. Explore the collection.



SCAN FOR INSPIRATION



CREATE YOUR OWN STYLE

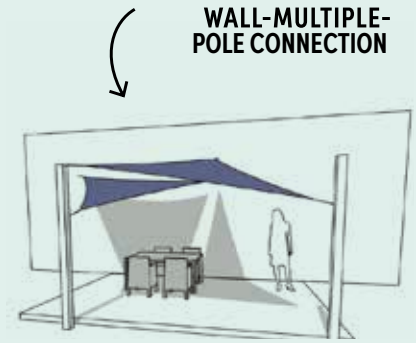
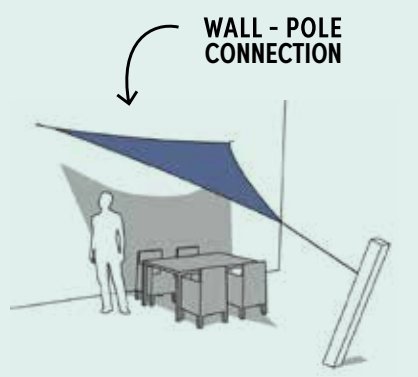
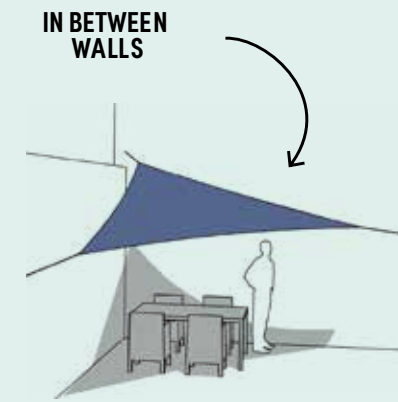
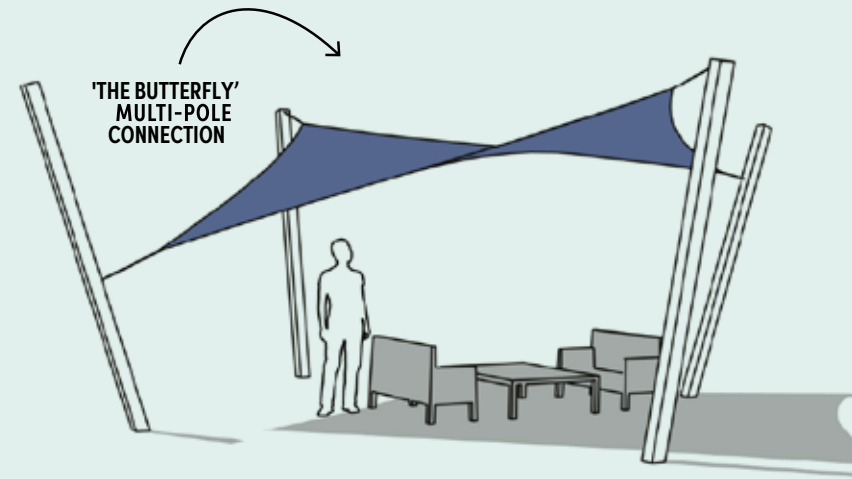

Ob Sie sich Schatten im Garten, auf der Terrasse oder dem Balkon wünschen – Platinum hat die passende Lösung für Sie.

Whether you crave shade in your garden, on your patio, or balcony, Platinum has the solution.



SONNENSEGEL
SHADE SAILS



BEFESTIGUNGSMATERIALIEN
MOUNTING MATERIALS



HARMONICA SONNENSEGEL
HARMONICA SHADE SAILS



AUSSENROLLOS
OUTDOOR ROLLER BLINDS



PERGOLEN
PERGOLAS



BALKON- BESCHATTUNG
BALCONY SOLUTIONS

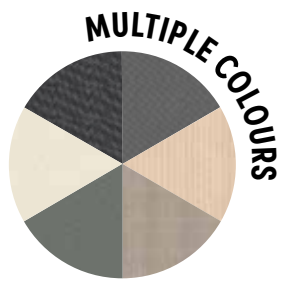

COOLFIT® SONNENSEGEL

OUTDOORABLE FUNKTIONEN / FEATURES



**STRONG WOVEN
HDPE 285 G/M2**



**BREATHES TO
KEEP YOU COOLER**



**HIGH COLOUR
FASTNESS
UP TO 95%
UV PROTECTION**







**316 MARINE GRADE
STAINLESS STEEL
HARDWARE**

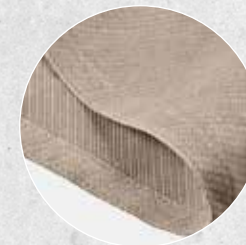

**5 YEAR
WARRANTY
ON FABRIC**



Size (cm)	285 gr. Coolfit						
	Anthracite	Sand	Ecru White	Black	Olive	Greige	
TRIANGLE 	360 x 360 x 360	1001	1001U	1001V	1001D	1001T	1001X
	500 x 500 x 500	1003	1003U	1003V	1003D	1003T	1003X
TRIANGLE 90° 	570 x 400 x 400	1002	1002U	1002V	1002D	1002T	1002X
	710 x 500 x 500	1004	1004U	1004V	1004D	1004T	1004X
SQUARE 	360 x 360	1005	1005U	1005V	1005D	1005T	1005X
	500 x 500	1008	1008U	1008V	1008D	1008T	1008X
RECTANGLE 	400 x 300	1006	1006U	1006V	1006D	1006T	1006X
	500 x 300	1007	1007U	1007V	1007D		

IN THE SHADE
BUT NOT IN
THE DARK

COOLFIT® SHADE SAILS

Ein Coolfit®-Sonnensegel ist sehr vielseitig und eine perfekte Ergänzung für einen Garten oder eine Terrasse. Die offene Struktur des Gewebes vermittelt ein angenehmes und großzügiges Gefühl, ist wasser- und winddurchlässig und kann daher die ganze Saison über an seinem Platz bleiben. Von Frühjahr bis Herbst.

- Ein starkes 285 g/m² HDPE-Gewebe.
- Angenehm großzügig und kühlend.
- Hochwertige Verarbeitung mit breiten Kanten.
- Befestigungsmaterialien aus Edelstahl 316 AISI höchster Qualität.
- Optimaler Sonnenschutz; bis zu 95% UV-Schutz.
- Witterungsbeständig und pflegeleicht.

A Coolfit® shade sail is very versatile and a perfect addition to a garden or terrace. The open structure of the fabric gives a pleasant and spacious feeling, is water and wind permeable and therefore can stay outside throughout the season. From March to September.

- A strong HDPE woven fabric of 285 g/m².
- Pleasantly spacious & cooling.
- High-quality finish with wide edges.
- Highest quality stainless steel 316 AISI delta rings.
- Optimal sun protection; up to 95% UV protection.
- Weather-resistant and low-maintenance.



PLATINUM®

DREAMSAIL®

SONNENSEGEL

OUTDOORABLE FUNKTIONEN / FEATURES



**FINE WOVEN
POLYESTER
220 G/M2**



WATERPROOF



**HIGH COLOUR
FASTNESS
UP TO 95%
UV PROTECTION**



**316 MARINE GRADE
STAINLESS STEEL
HARDWARE**



**3 YEAR
WARRANTY
ON FABRIC**



TRIANGLE



SQUARE



Size (cm)	220 gr. Dreamsail	
	Grey	Ecru
400 x 400 x 400	1100W	1100B
	500 x 500 x 500	1101W
400 x 400	1102W	1102B
	500 x 500	1103W

ENJOY
OUTDOOR
LIVING ALL
YEAR LONG

DREAMSAIL® SHADE SAILS

Mit dem Dreamsail®-Sonnensegel können Sie den Aufenthalt im Freien noch länger genießen. Dank des fein gewebten Polyestergewebes mit PU-Beschichtung ist das Dreamsail®-Sonnensegel wasserdicht, so dass man auch bei Nieselregen draußen sitzen kann.

- Ein starkes Gewebe aus 100% Polyester mit 220 g/m².
- Wasserdicht durch dichte Struktur und PU-Beschichtung.
- Hochwertige Verarbeitung mit breiten Kanten.
- Befestigungsmaterial aus rostfreiem Stahl 316 AISI von höchster Qualität.
- Witterungsbeständig und pflegeleicht.

Das Dreamsail®-Sonnensegel muss in einem Winkel von mindestens 30° aufgehängt werden, um eine gute Entwässerung zu gewährleisten.

With the Dreamsail® shade sail you can enjoy the outdoors even longer. Thanks to the finely woven Polyester fabric with the PU coating, this fabric is waterproof, which makes it possible to sit outside even when it's drizzling.

- A strong 100% Polyester fabric of 220 g/m².
- Waterproof due to dense structure and PU coating.
- High-quality finish with wide edges.
- Highest quality stainless steel 316 AISI delta rings.
- Weather-resistant and low-maintenance.



PLATINUM®

BEFESTIGUNGS- MATERIAL



MOUNTING MATERIALS

FÜR COOLFIT & DREAMSAIL SONNENSEGEL
FOR COOLFIT® & DREAMSAIL® SHADE SAILS

SPANNANKER M8 / TURNBUCKLE M8
2000



KARABINERHAKEN 8X 80 MM
SNAPHOOK 8 X 80 MM
2002



**RINGSCHRAUBE MIT MUTTER FÜR
HOLZPFAHL M8 X 100 MM**
EYE BOLT WITH NUT FOR WOODEN
POLE M8 X 100 MM
2004



WANDÖSE / PAD EYE
2006



SCHIENE MIT ÖSE 1M
RAILS WITH EYE 1M
2011



SPANNANKER M10 / TURNBUCKLE M10
2001



ANKER MIT RINGSCHRAUBE M8
ANCHOR WITH EYEBOLT M8
2003



GLIEDERKETTE 4 MM- 2M LANG /
CHAIN LINK 4 MM
2M LANG
2005



SCHRAUBEN 20 STÜCK / SCREWS
20 PIECES
2007



BODENHÜLSE / ANCHOR
2013



MAST MIT FLEXÖSE
7 X 7 X 250 CM
POLE WITH
FLEX EYE
7 X 7 X 250 CM
2012



**MONTAGESETS
FÜR SONNEN-
SEGEL**
MOUNTING
SETS FOR
SHADE SAILS



N317-1



N317-2



N317-3

* Alle Befestigungsmaterialien sind aus rostfreiem Stahl 316 AISI gefertigt.
* Der Pfosten mit Flexöse ist aus pulverbeschichtetem Stahl gefertigt RAL 7016.
* Der Pfostenanker sollte 70 cm tief im Boden, mit Hilfe von Beton, verankert werden.

* All mounting materials are made of stainless steel 316 AISI
* The pole with flex eye is made of powder-coated steel ral 7016.
* The anchor must be placed 70cm in the ground using concrete. The pole slides over it.

COOLFIT® HARMONICA-MARKISE



OUTDOORABLE FUNKTIONEN / FEATURES



**STRONG WOVEN
HDPE 285 G/M2**



**BREATHES TO
KEEP YOU COOLER**



**HIGH COLOUR
FASTNESS
UP TO 95%
UV PROTECTION**



**316 MARINE GRADE
STAINLESS STEEL
HARDWARE**



**5 YEAR
WARRANTY
ON FABRIC**



Size (cm)	285 gr. Coolfit				
	Anthracite	Sand	Off White	Black	Greige
W200 x L300	1400	1400U	1400V		1400X <small>NEW</small>
W200 x L400	1401	1401U	1401V		1401X <small>NEW</small>
W200 x L500	1402	1402U	1402V		1402X <small>NEW</small>
W290 x L300	1403	1403U	1403V	1403D	1403X <small>NEW</small>
W290 x L400	1404	1404U	1404V	1404D	1404X <small>NEW</small>
W290 x L500	1405	1405U	1405V	1405D	1405X <small>NEW</small>
W370 x L370	1406	1406U	1406V		1406X <small>NEW</small>
W370 x L500	1407	1407U	1407V		1407X <small>NEW</small>

SUN OR
SHADE,
IT'S YOUR
CHOICE

COOLFIT® HARMONICA SHADE SAIL

Mit der Coolfit®-Harmonica-Markise lässt sich die Sonneneinstrahlung auf der Terrasse ganz einfach bestimmen. Die Markise läuft auf Edelstahlseilen und kann manuell geöffnet und geschlossen werden. Die Coolfit®-Harmonica-Markisen werden mit Montagezubehör geliefert: Rollen, Rippen, Stahlseile, Seile und Spanner. Die Montage ist mit Hilfe der mitgelieferten Montageanleitung und unserer Montagevideos auf der Website einfach zu bewerkstelligen.

Easily determine the amount of sun on the terrace with the Coolfit® harmonica shade. The shade runs over stainless steel cables and can open or close manually. In addition, the Coolfit® harmonica shade is supplied including mounting material; pulleys, rods, steel cables, rope and tensioners. Easy to install by using the included assembly instructions and our assembly instruction on the website.

Size (cm)	Art. nr.
200	2800
290	2801
370	2802

Entfernen Sie im Winter die Coolfit®-Harmonica-Markise oder verwenden Sie die Schutzhülle. Mit dieser Hülle kann die Harmonica-Markise im Winter hängen bleiben.



Remove the Coolfit® harmonica shade in the winter. To make it easier there is a winter cover available. With this cover the harmonica shade can stay outside during the winter.



PLATINUM®

PROSAIL®

WASSERDICHTE HARMONICA-MARKISE



OUTDOORABLE FUNKTIONEN / FEATURES



HIGH QUALITY ACRYLIC



WATERPROOF



HIGH COLOUR FASTNESS
UP TO 95% UV PROTECTION



3 YEAR WARRANTY ON FABRIC



Size (cm)	300 gr. Prosail
	Grey
W297 x L297	1500
W297 x L397	1501

ENJOY THE OUTDOORS IN ANY WEATHER

PROSAIL® WATERPROOF HARMONICA SHADE SAIL

Mit der wasserdichten Harmonica-Markise von Prosail® können Sie jetzt auch bei einem leichten Regenschauer die freie Natur genießen! Dieser Stoff bietet nicht nur die Vorteile einer Harmonica-Markise, sondern auch die eines wasserdichten Sonnensegels. Das Prosail® lässt sich einfach mit einem Seil öffnen und schließen. Wenn das Tuch vollständig gefaltet ist, sind keine Stahldrähte sichtbar. Die Sicht ist also dank der Führungen, in denen das Tuch läuft, völlig frei. Der Stoff besteht aus hochwertigem Acryl und ist absolut wasserdicht. So können Sie auch bei einem leichten Regenschauer trocken sitzen. Die wasserdichte Prosail® Harmonica-Markise kann mit oder ohne Aluminium-Pergola geliefert werden.

Enjoy the outdoors even longer with the Prosail® waterproof harmonica! This waterproof Harmonica shade offers not only the advantages of a harmonica shade, but those of a waterproof shade sail as well. The Prosail® can be easily opened and closed with a rope and pulley system. When the fabric is fully folded in, no steel wires are visible. The view is therefore completely free thanks to the conductors onto which the Prosail runs. The shade sail is made of high-quality acrylic and is completely waterproof. This way you are comfortable during a rain shower.



PLATINUM®

COOLFIT® AUSSENROLLOS



OUTDOORABLE FUNKTIONEN / FEATURES



**STRONG WOVEN
HDPE 285 G/M2**



**BREATHES TO
KEEP YOU COOLER**



**HIGH COLOUR
FASTNESS
UP TO 95%
UV PROTECTION**



**316 MARINE GRADE
STAINLESS STEEL
HARDWARE**



**5 YEAR
WARRANTY
ON FABRIC**

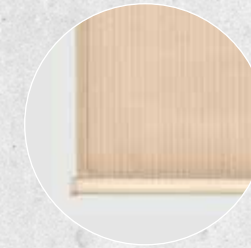

Size (cm)	285 gr. Coolfit				
	Anthracite	Sand	Off White	Black	Greige
W98 x L240	1700	1700U	1700V	1700D	
W148 x L240	1701	1701U	1701V	1701D	
W198 x L240	1702	1702U	1702V	1702D	1702X
W248 x L240	1703	1703U	1703V	1703D	1703X
W296 x L240	1704	1704U	1704V	1704D	1704X

SHADE
AND
PRIVACY

COOLFIT® OUTDOOR ROLLER BLINDS

Die Coolfit®-Rollos sind ideal bei niedrigem Sonnenstand. Neben dem Sonnenschutz sorgen die Rollos auch für eine private Atmosphäre. Die Montage ist sowohl an der Außenseite als auch an der Innenseite des Pergola-Rahmens möglich. Die Rollos sind auch aus dem Coolfit®-Gewebe gefertigt, das bis zu 95% der schädlichen UV-Strahlen filtert und winddurchlässig ist.

Die Coolfit®-Rollos lassen sich hervorragend mit einer Optiva-Pergola (siehe Seite 18-19) oder mit dem Flex-Rahmen (siehe Seite 23) kombinieren.

The Coolfit® roller blinds are ideal in low sun conditions. In addition to the sun protection, the roller blinds also provide an intimate atmosphere. Mounting is possible both on the window frame as well as inside the window frame. The blinds are also made from the Coolfit® fabric, which means that they filter up to 95% of harmful UV-rays and are wind permeable.

The roller blinds are excellent to combine with a Optiva pergola (see page 18 to 19) or with the Flex frame (see page 23).



PLATINUM®

OPTIVA ALUMINIUM PERGOLA



OUTDOORABLE FUNKTIONEN / FEATURES

OPTIVA COOLFIT



STRONG WOVEN
HDPE 285 G/M2



316 MARINE GRADE
STAINLESS STEEL
HARDWARE



BREATHES TO
KEEP YOU COOLER



5 YEAR
WARRANTY
ON FABRIC



HIGH COLOUR
FASTNESS
UP TO 95%
UV PROTECTION

Size (cm)	285 gr. Coolfit		
	Anthracite	Sand	Off White
319 x 319	2300	2300U	2300V
319 x 419	2301	2301U	2301V
402 x 402	2302	2302U	2302V

OPTIVA PROSAIL



HIGH QUALITY
ACRYLIC



WATERPROOF



HIGH COLOUR
FASTNESS
UP TO 95%
UV PROTECTION



3 YEAR
WARRANTY
ON FABRIC

Size (cm)	300 gr. Prosail	
	Grey	Prosail roof
319 x 319	2303	297 x 32,3 2390
319 x 419	2304	297 x 47,3 2391

GIVE YOUR GARDEN
AMBIENCE WITH AN
ALUMINIUM PERGOLA

OPTIVA ALUMINIUM PERGOLA

Mögen Sie einen modernen und schlichten Look im Garten? Dann ist die Aluminium-Pergola ideal. Die Aluminium-Pergola kann sowohl mit Coolfit®-Harmonica-Markise als auch mit wasserdichter Prosail®-Harmonica-Markise geliefert werden. Eine passende Lösung für jeden Garten. Die Pergola sollte auf einem Holz- oder Steinsockel oder mit längeren Pfosten in der Erde aufgestellt werden. Die Pfosten sind 11 x 11 cm stark.

Do you like a modern and sleek look in the garden? Then the aluminum pergola is extremely suitable. The aluminum pergola can be used with the Coolfit® harmonica shade and with the Prosail® waterproof harmonica shade. A suitable solution for every garden. The pergola can be installed on a wooden or stone base. The pole size is 11 x 11 cm.

OPTIVA COOLFIT



OPTIVA PROSAIL



PERGOLA KITS



OUTDOORABLE FUNKTIONEN / FEATURES



CORNER SUPPORT







WALL SUPPORT



CONNECTION SUPPORT



FLOOR SUPPORT

	Description	Art. nr.
	Corner support, set/2	2200
	Wall support, set/2	2201
	Connection support, set/2	2202
	Floor support, set/2	2203

BUILD YOUR
OWN WOODEN
PERGOLA

BAUEN WIR UNSERE EIGENE HOLZPERGOLA

Verleihen Sie Ihrem Garten Atmosphäre und Gemütlichkeit mit einer Pergola aus Holz. Sie sorgen für das Holz und Platinum liefert die Pergola-Bausätze, oder das Rollo. Scannen Sie den QR-Code für weitere Informationen und eine Schritt-für-Schritt-Bauanleitung. Die Elemente der Platinum® Pergola-Bausätze sind aus pulverbeschichtetem Stahl in der Farbe RAL 7016 gefertigt. Die Kits können separat bestellt werden (paarweise verpackt). Geeignet für Balken von 8,5 - 12 cm Stärke.

Give your garden atmosphere and cosiness with a wooden pergola. You take care of the wood and Nesling provides the pergola kits, the Coolfit® harmonica shade or roller blind. Scan the QR code for more information and a step by step construction guide. The pergola kits are made of powder-coated steel in the colour 7016. The kits can be ordered separately (packed by two pieces).



PLATINUM®



COOLFIT® BALKON SICHTSCHUTZ BALCONY SCREEN

Mit dem Coolfit®-Balkontuch schaffen Sie nicht nur Schatten, sondern auch Privatsphäre. Das Balkontuch hat alle 50 cm eine Öse. Damit das Tuch einfach an den Balkongeländern befestigt werden kann, werden Bindebänder mitgeliefert.

With the Coolfit® balcony screen you can create shade and privacy. The balcony shade has one eye every 50 cm tie wraps are included so that the shade is easy to attach to the balcony fence.



**STRONG WOVEN
HDPE 285 G/M2**



**316 MARINE GRADE
STAINLESS STEEL
HARDWARE**



**BREATHES TO
KEEP YOU COOLER**



**5 YEAR
WARRANTY
ON FABRIC**

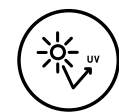

**HIGH COLOUR
FASTNESS
UP TO 95%
UV PROTECTION**



Size (cm)	285 gr. Coolfit		
	Anthracite	Sand	Off White
500 x 80	1900	1900U	1900V

STAY COOL
ON YOUR
BALCONY



FLEX FRAME

Mit einem Flex Frame in Kombination mit einem Coolfit®-Rollo entsteht im Handumdrehen eine Balkonmarkise. Der Flex Frame besteht aus zwei Pfosten mit einem Zwischenarm und wird zwischen Boden und Decke geklemmt. Sie können sogar mehrere Flex Frames nebeneinander mit einem Verbindungspfosten montieren.

Geeignet für alle Coolfit®-Rollo ab 148 cm. Kleinere Größen können auf Anfrage gefertigt werden. Bitte beachten: Rollo separat bestellen.

A Flex Frame in combination with a Coolfit® roller blind creates a balcony awning in no time. The Flex Frame consists of two posts with one intermediate arm and should be clamped between floor and ceiling. You can even mount several Flex Frames next to each other with a connection post.

Suitable for all Coolfit® roller blinds from 148 cm. Roller blind not included.



NO DRILL



EASY TO USE



**USE WITH
COOLFIT
ROLLER BLIND**

Description	Art. nr.
Flex frame	1950

Description	Art. nr.
Flex frame connection part	1951

FLEX FRAME

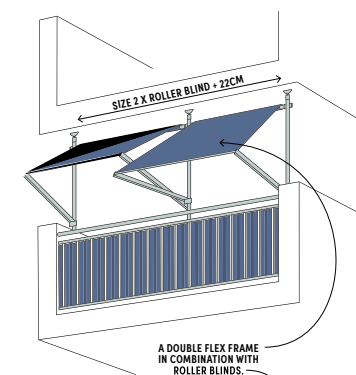
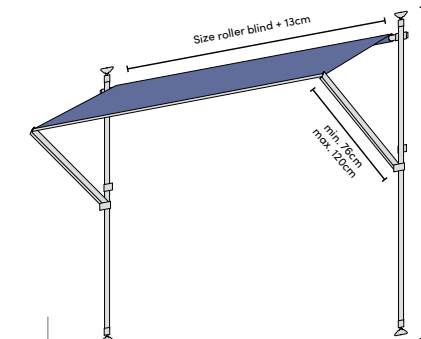

FLEX FRAME CONNECTION

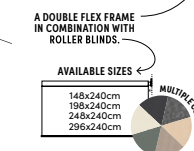

EASY SUN
SHADE FOR
THE BALCONY

AUSWAHLHILFE / DECISION AID

Haben Sie Schwierigkeiten, die richtige Größe für das Sonnensegel auszuwählen? Oder sind Sie sich unsicher, welche Befestigungsmaterialien in Ihrer Situation am besten geeignet sind? Diese Entscheidungshilfe macht es Ihnen einfach.

Are you finding it difficult to choose the correct size shade sail? Or are you doubting which mounting materials are best in your situation? This decision aid makes it easy.

SONNENSEGEL / SHADE SAIL

1 WÄHLEN SIE COOLFIT® ODER DREAMSAIL® (Seite 6-9) / CHOOSE COOLFIT® OR DREAMSAIL® (see page 6-9)

2 AUFHÄNGEN WÄHLEN SIE DIE RICHTIGEN MATERIALEN / MOUNTING CHOOSE THE RIGHT MATERIALS

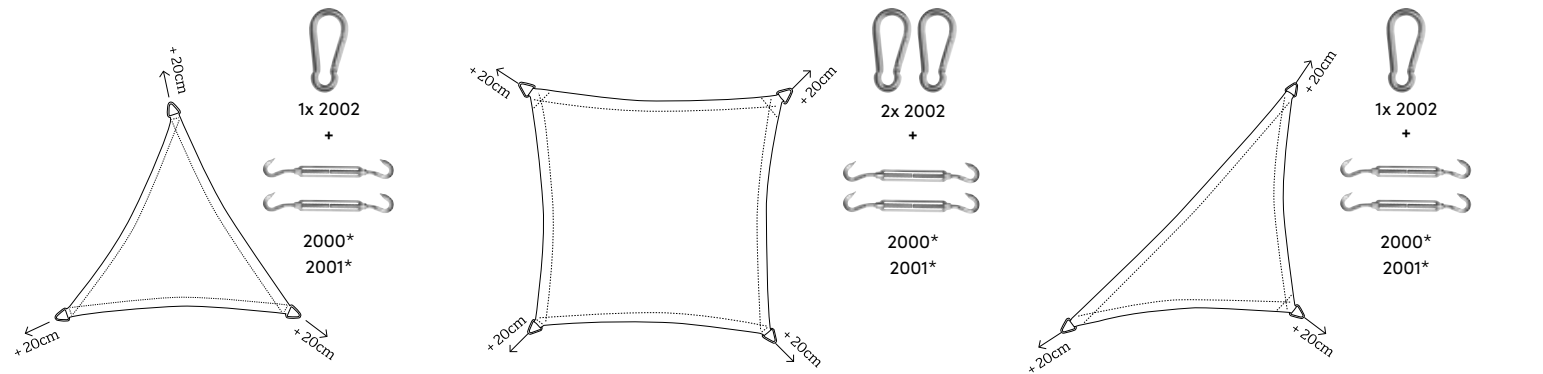

*Längste Seite / Longest side < 5m: 2x art. 2000 (M8)
*Längste Seite / Longest side > 5m: 2x art. 2001

3 BEFESTIGEN WÄHLEN SIE DIE RICHTIGEN MATERIALEN FÜR JEDEN BEFESTIGUNGSPUNKT

ATTACHMENT CHOOSE THE RIGHT MATERIALS FOR EACH MOUNTING POINT

<p>Stahlmast mit Flexöse 2012 + Pfostenanker 2013</p> <p>Steel pole with adjustable eye 2012 + pole anchor 2013</p>	<p>MIT VARIABLER DISTANZ WITH VARIABLE DISTANCE</p> <p>2005 + 2002</p>	<p>AN DER WAND / TO A WALL</p> <p>2003 / 2006</p>	<p>AUF HOLZ / ON WOOD</p> <p>2011</p> <p>2004 / 2006</p>
---------------------------------------------------------------------------------------------------------------------	------------------------------------------------------------------------	---------------------------------------------------	----------------------------------------------------------

HARMONICA

1 WÄHLEN SIE COOLFIT® HARMONICA (Seite 12-13) CHOOSE COOLFIT® HARMONICA® (see page 12-15)

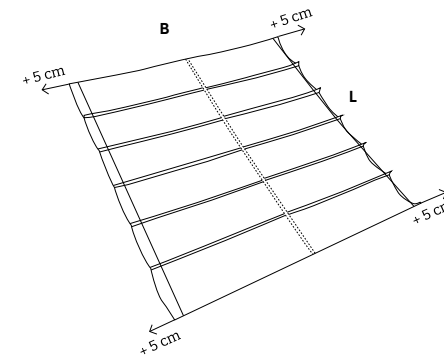

B X H / W X H
2,0 x 3,0 m
2,0 x 4,0 m
2,0 x 5,0 m
2,9 x 3,0 m
2,9 x 4,0 m
2,9 x 5,0 m
3,7 x 3,7 m
3,7 x 5,0 m

EINSCHLIESSLICH BEFESTIGUNGSMATERIALIEN
INCLUDING MOUNTING HARDWARE

AUSSENROLLOS / ROLLER BLIND

1 WÄHLEN SIE COOLFIT® AUSSENROLLOS (Seite 16-17) CHOOSE COOLFIT® ROLLER BLIND (see page 16-17)

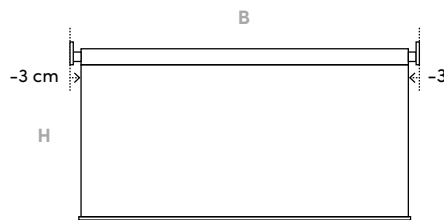

B X H / W X H
98 x 240 cm
148 x 240 cm
198 x 240 cm
248 x 240 cm
296 x 240 cm

EINSCHLIESSLICH BEFESTIGUNGSMATERIALIEN
INCLUDING MOUNTING HARDWARE SET

2 WÄHLEN SIE PERGOLA (Seite 18-21) CHOOSE PERGOLA (see page 18-21)

Bestellen Sie Ihre komplette Aluminium-Pergola
Order your complete aluminium pergola



Oder bauen Sie Ihre eigene Holzpergola mit den Pergola-Bausätzen
Or build your own wooden pergola with the pergola kits



2203 2200 2201 2202

2 FLEXIBEL ZU MONTIEREN FLEXIBLE MOUNT

Befestigen Sie das Rollo innen oder außen am Rahmen
Mount the roller blind inside or outside the frame

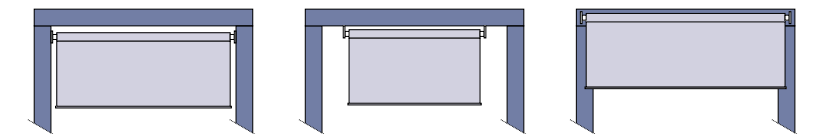

OUTDOORABLE PARTY

OUTDOORABLE

Entdecken Sie noch weitere Beschaffungslösungen
Discover other shade solutions

www.platinum.nl

PLATINUM

AEROCOVER

ATMUNGSAKTIVER SCHUTZ BREATHABLE PROTECTION

Schützen Sie Ihren Sonnenschirm und Ihre Gartenmöbel vor Regen, Schmutz und Staub und reduzieren Sie Schimmel mit den atmungsaktiven Abdeckungen von Platinum AeroCover®. Sie halten die Möbel sauber, verringern den Verschleiß, verhindern Verfärbungen und verlängern deren Lebensdauer. Für weitere Informationen und Pflegehinweise besuchen Sie www.platinum.nl.

Protect your parasol and garden furniture from rain, dirt and dust and reduce mildew with Platinum AeroCover® breathable covers. They keep the furniture clean, reduce wear and tear, prevent discolouration and extend its lifespan. For more information and maintenance tips, visit www.platinum.nl.



BREATHABLE PROTECTION



HIGH COLOUR FASTNESS



STRONG & LIGHT WEIGHT



WEATHER PROOF



EASY TO USE

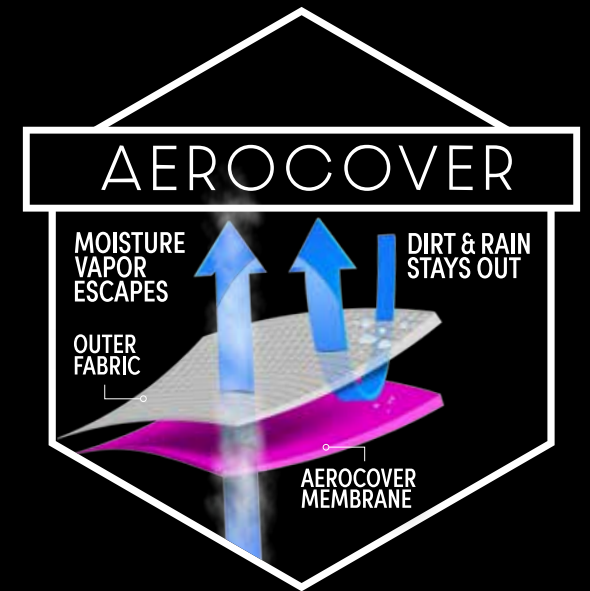

PLATINUM

OUTDOORABLE

www.platinum.nl